

DATA SHEET

PCR Plates

ISO 9001

ISO 13485

Features

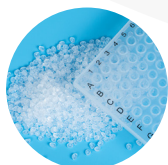

After over 30 tests, we have identified the best polypropylene material for PCR thermal cycling.



The uniform thin wall thickness ensures optimal heat transfer.

Various specifications available: no skirt, half skirt, full skirt to meet different needs.



The alphabetic grid ensures easy and precise identification.

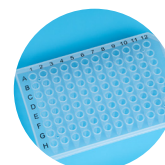

Free from RNase, DNase, heavy metals, and human DNA contamination.



Raw Material

The plates are manufactured from medical-grade polypropylene.

Application

The PCR plate serves as a crucial tool for conducting polymerase chain reaction (PCR) experiments. It is particularly well-suited for high-throughput screening thermal cycler applications and boasts compatibility with most thermal cyclers. The plate streamlines the process, allowing for rapid fragment amplification without manual intervention. Its versatility extends to applications such as gene expression analysis, pathogen detection, DNA cloning, library preparation, and numerous other research endeavours.

We Open To New Ideas!

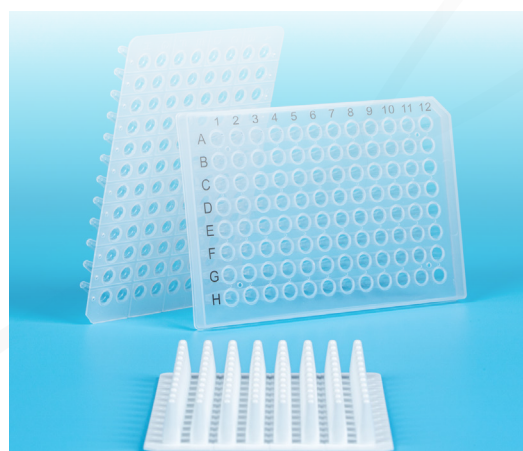

SHAOXING GENFOLLOWER BIOTECH CO.,LTD.

Add: Eastern industrial park, Baiguan street, Shangyu district,

Shaoxing city, Zhejiang province, China

Email: GenFollower@Genfollower.com

Web: www.GenFollower.com

Fax: +86-575-82032762

Tel: +86-575-82936953

**GenFollower**[®]

DATA SHEET

PCR Plates

ISO 9001

ISO 13485

Product Range

CAT	Description	Packaging
A384FS-004N	40uL Full-Skirt G2 PCR plates, Nature, sterile, RNase and DNase free	15 PCS/box, 10 Boxes/Case
A384FS-004W	40uL Full-Skirt G2 PCR plates, White, sterile, RNase and DNase free	15 PCS/box, 10 Boxes/Case
B96NS-01N	0.1mL Non-Skirt G2 PCR plates, Nature, sterile, RNase and DNase free	15 PCS/box, 10 Boxes/Case
B96NS-01W	0.1mL Non-Skirt G2 PCR plates, White, sterile, RNase and DNase free	15 PCS/box, 10 Boxes/Case
B96NS-02N	0.2mL Non-Skirt G2 PCR plates, Nature, sterile, RNase and DNase free	15 PCS/box, 10 Boxes/Case
B96NS-02W	0.2mL Non-Skirt G2 PCR plates, White, sterile, RNase and DNase free	15 PCS/box, 10 Boxes/Case
B96HS-01N	0.1mL Half-Skirt G2 PCR plates, Nature, sterile, RNase and DNase free	15 PCS/box, 10 Boxes/Case
B96HS-01W	0.1mL Half-Skirt G2 PCR plates, White, sterile, RNase and DNase free	15 PCS/box, 10 Boxes/Case
B96HS-02N	0.2mL Half-Skirt G2 PCR plates, Nature, sterile, RNase and DNase free	15 PCS/box, 10 Boxes/Case
B96HS-02W	0.2mL Half-Skirt G2 PCR plates, White, sterile, RNase and DNase free	15 PCS/box, 10 Boxes/Case
A96WS-02N	0.2mL Half-Skirt G2 PCR plates, Nature, sterile, RNase and DNase free	15 PCS/box, 10 Boxes/Case
A96WS-02W	0.2mL Half-Skirt G2 PCR plates, White, sterile, RNase and DNase free	15 PCS/box, 10 Boxes/Case
A96WS-02PN	0.2mL Half-Skirt G2 PCR plates, Nature, sterile, RNase and DNase free	15 PCS/box, 10 Boxes/Case
T96HS-02N	0.2mL Half-Skirt G2 PCR plates, Nature, sterile, RNase and DNase free	15 PCS/box, 10 Boxes/Case

Type

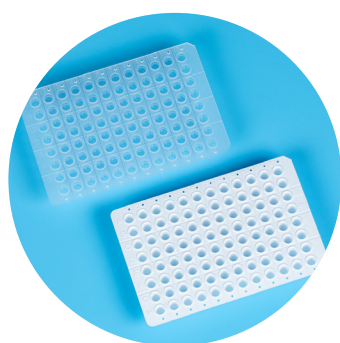

Color: Nature/White

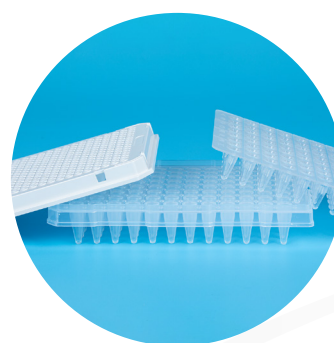

Specification:
Non-skirt/Half-skirt/Full-skirt

SHAOXING GENFOLLOWER BIOTECH CO.,LTD.

Add: Eastern industrial park, Baiguan street, Shangyu district,
Shaoxing city, Zhejiang province, China
Email: GenFollower@Genfollower.com
Web: www.GenFollower.com
Fax: +86-575-82032762
Tel: +86-575-82936953

**GenFollower**[®]

 **Technical Drawing - A384FS-004N+A384FS-004W**

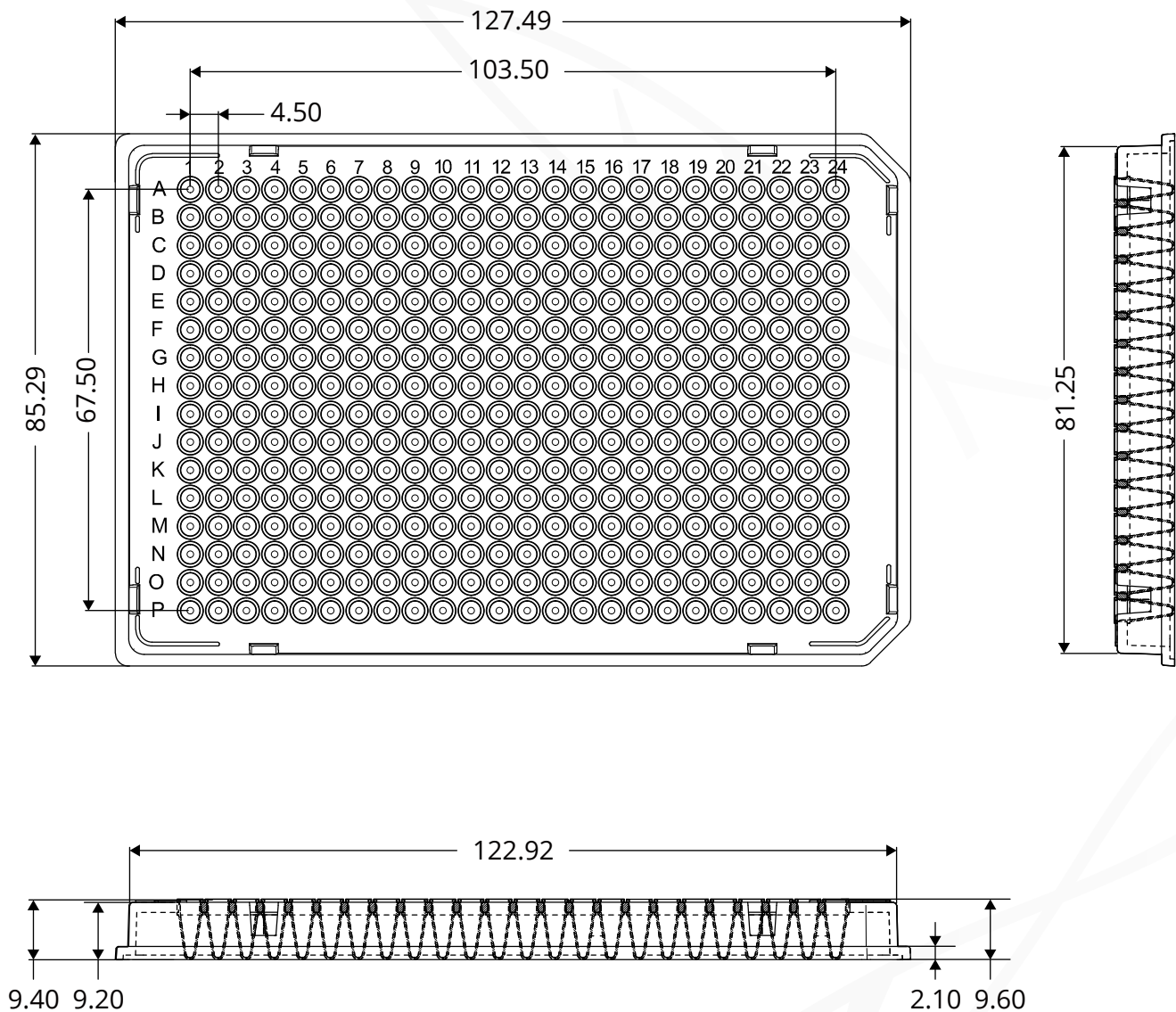

(Unit: mm)

SHAOXING GENFOLLOWER BIOTECH CO.,LTD.

Add: Eastern industrial park, Baiguan street, Shangyu district,
Shaoxing city, Zhejiang province, China
Email: GenFollower@Genfollower.com
Web: www.GenFollower.com
Fax: +86-575-82032762
Tel: +86-575-82936953

 **Technical Drawing - B96NS-01N+B96NS-01W**

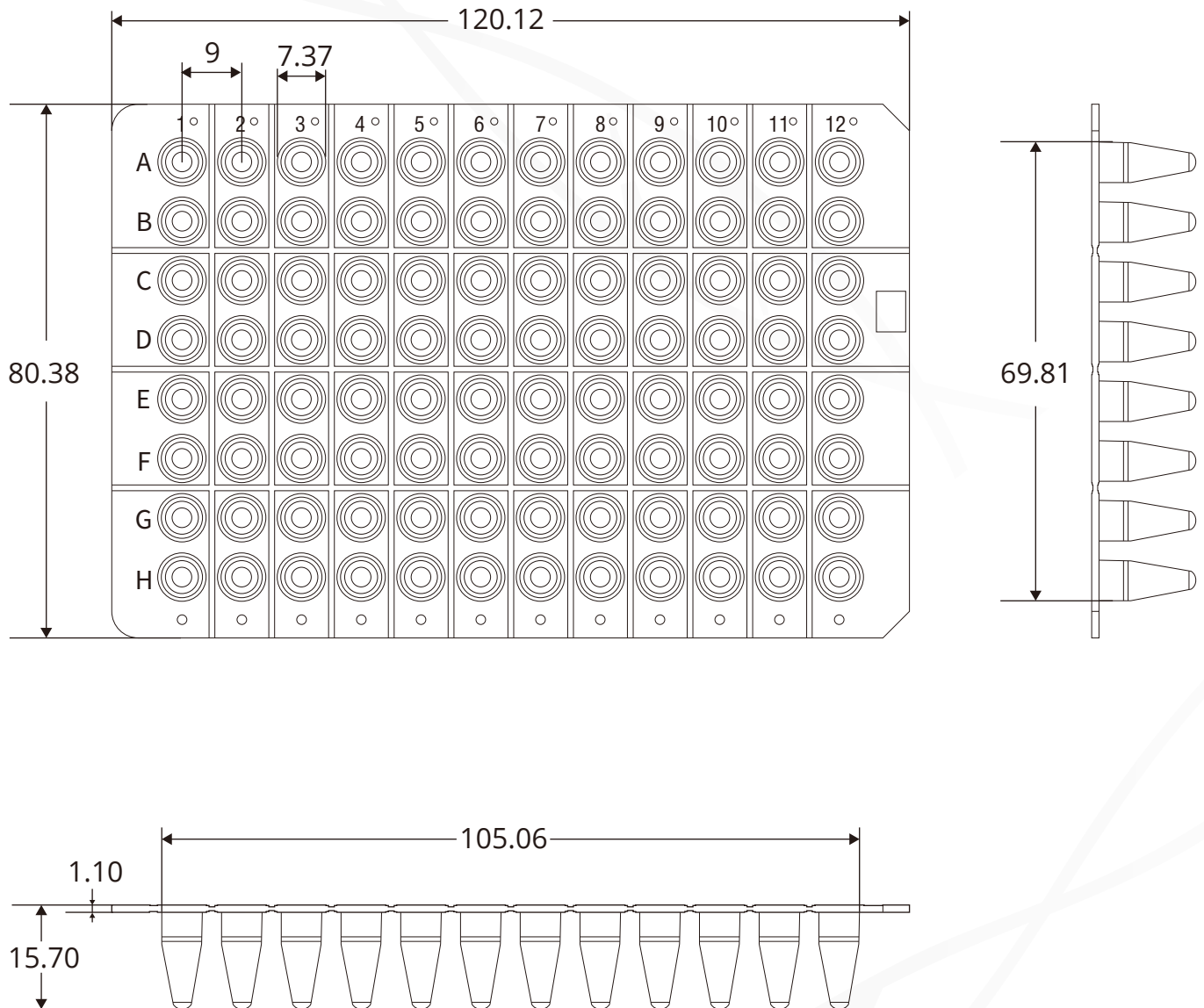

(Unit: mm)

SHAOXING GENFOLLOWER BIOTECH CO.,LTD.

Add: Eastern industrial park, Baiguan street, Shangyu district,
Shaoxing city, Zhejiang province, China
Email: GenFollower@Genfollower.com
Web: www.GenFollower.com
Fax: +86-575-82032762
Tel: +86-575-82936953

DATA SHEET

PCR Plates

ISO 9001

ISO 13485

Technical Drawing - B96NS-02N+B96NS-02W

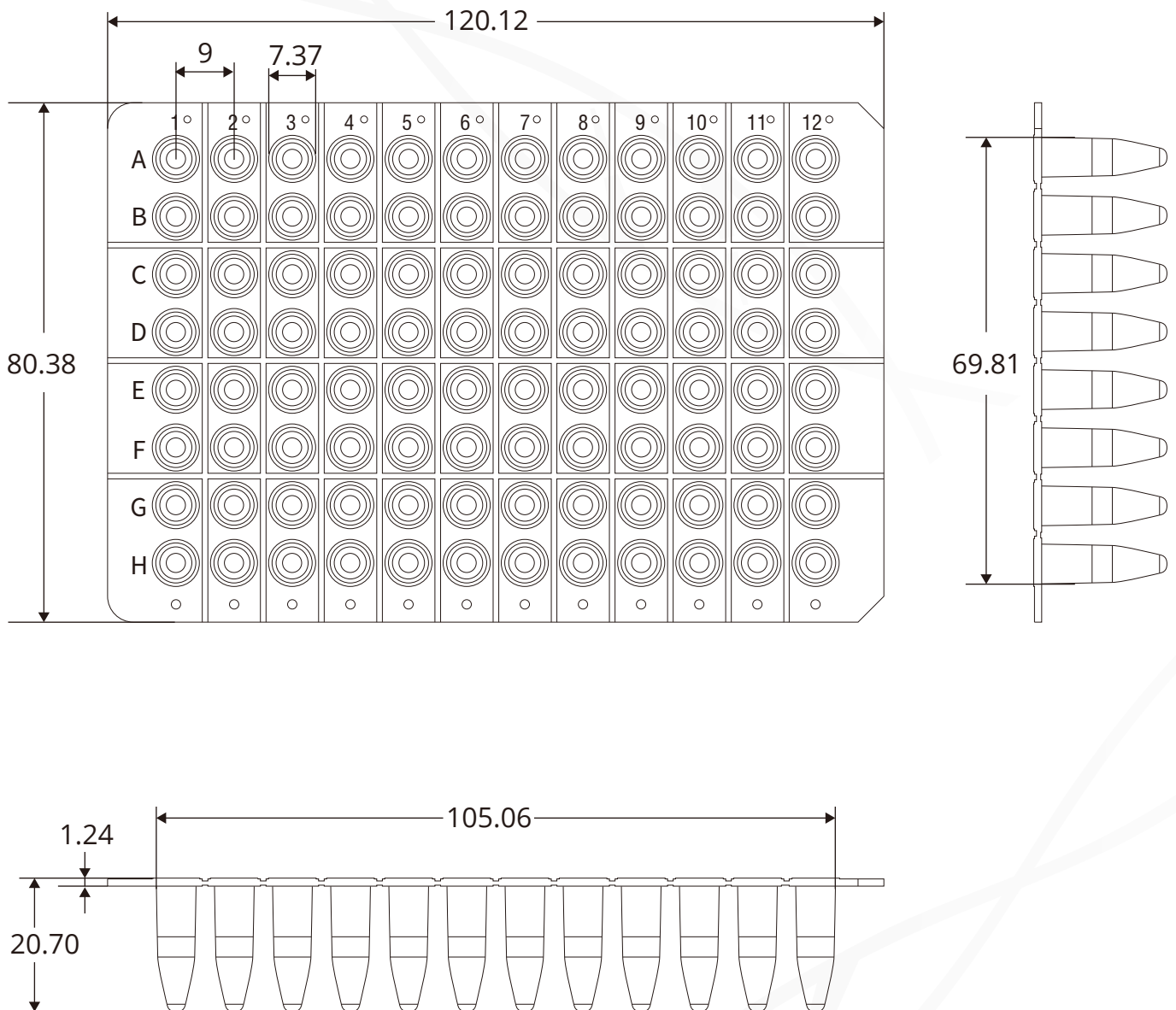

(Unit: mm)

SHAOXING GENFOLLOWER BIOTECH CO.,LTD.

Add: Eastern industrial park, Baiguan street, Shangyu district,
Shaoxing city, Zhejiang province, China
Email: GenFollower@Genfollower.com
Web: www.GenFollower.com
Fax: +86-575-82032762
Tel: +86-575-82936953



DATA SHEET

PCR Plates

ISO 9001

ISO 13485

Technical Drawing - B96HS-01N+B96HS-01W

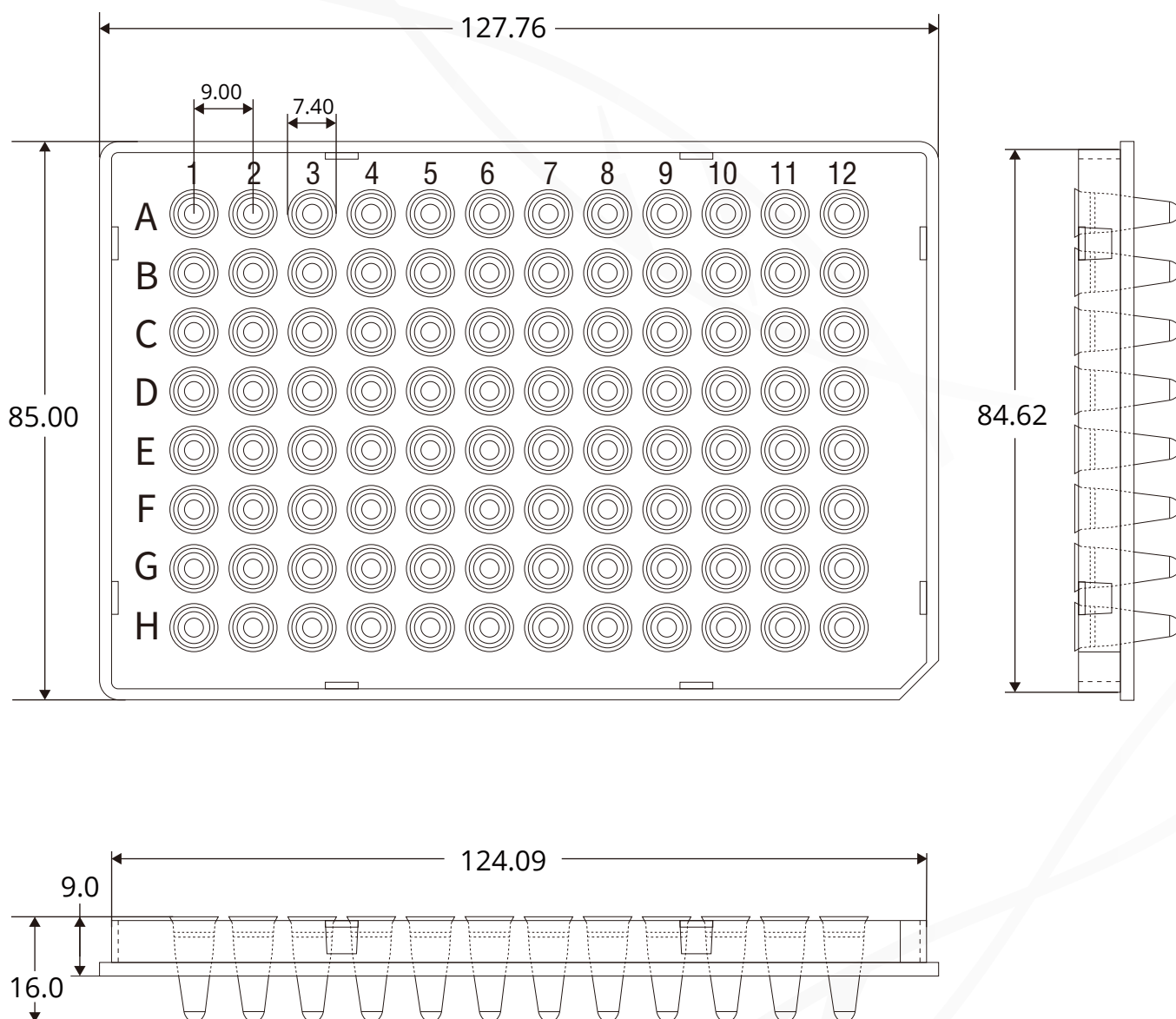

(Unit: mm)

SHAOXING GENFOLLOWER BIOTECH CO.,LTD.

Add: Eastern industrial park, Baiguan street, Shangyu district,

Shaoxing city, Zhejiang province, China

Email: GenFollower@Genfollower.com

Web: www.GenFollower.com

Fax: +86-575-82032762

Tel: +86-575-82936953

 GenFollower®

DATA SHEET

PCR Plates

ISO 9001

ISO 13485

Technical Drawing - B96HS-02N+B96HS-02W

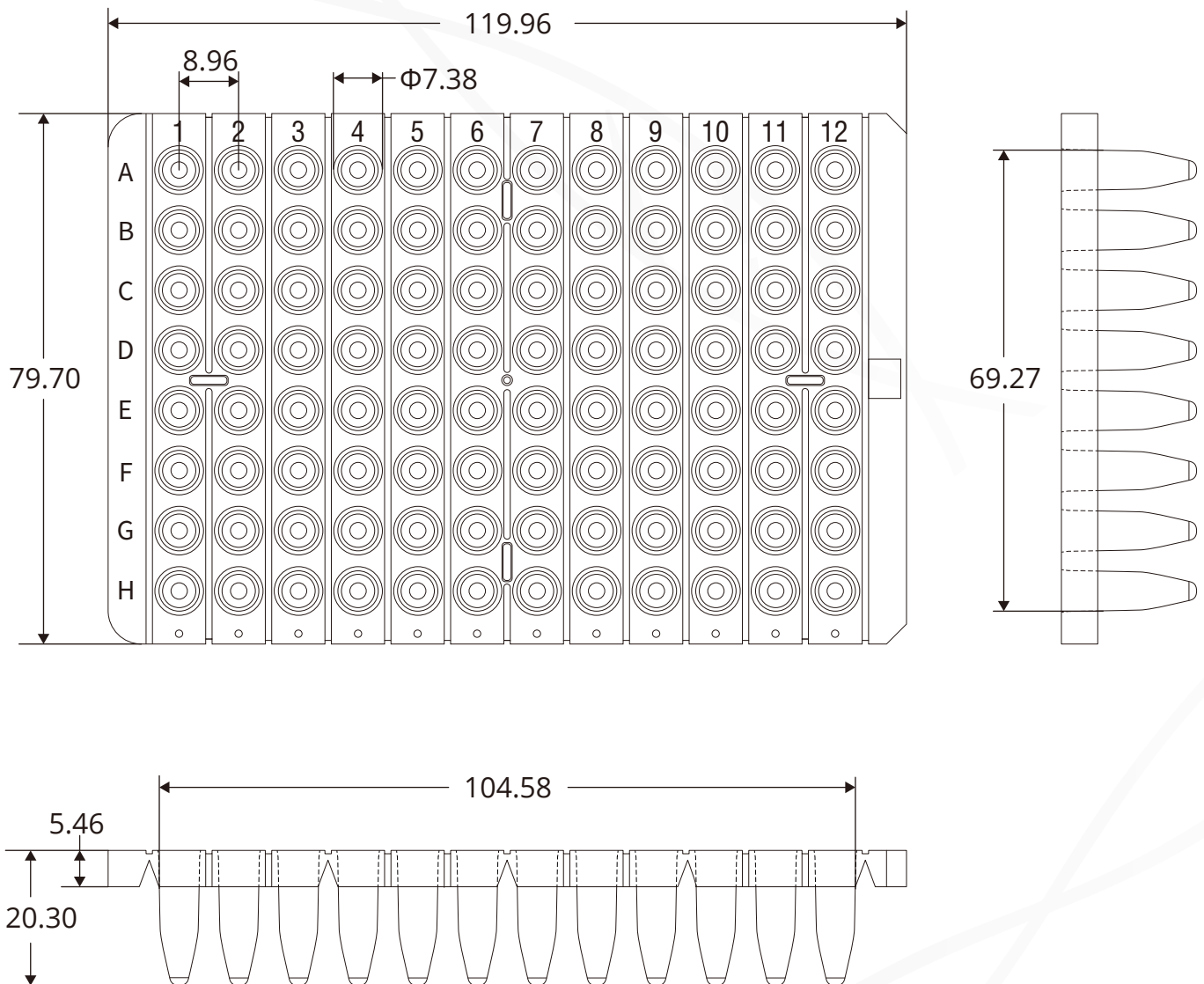

(Unit: mm)

SHAOXING GENFOLLOWER BIOTECH CO.,LTD.

Add: Eastern industrial park, Baiguan street, Shangyu district,
Shaoxing city, Zhejiang province, China
Email: GenFollower@Genfollower.com
Web: www.GenFollower.com
Fax: +86-575-82032762
Tel: +86-575-82936953

GenFollower®

 **Technical Drawing - A96WS-02N+A96WS-02W6+A96WS-02PN**

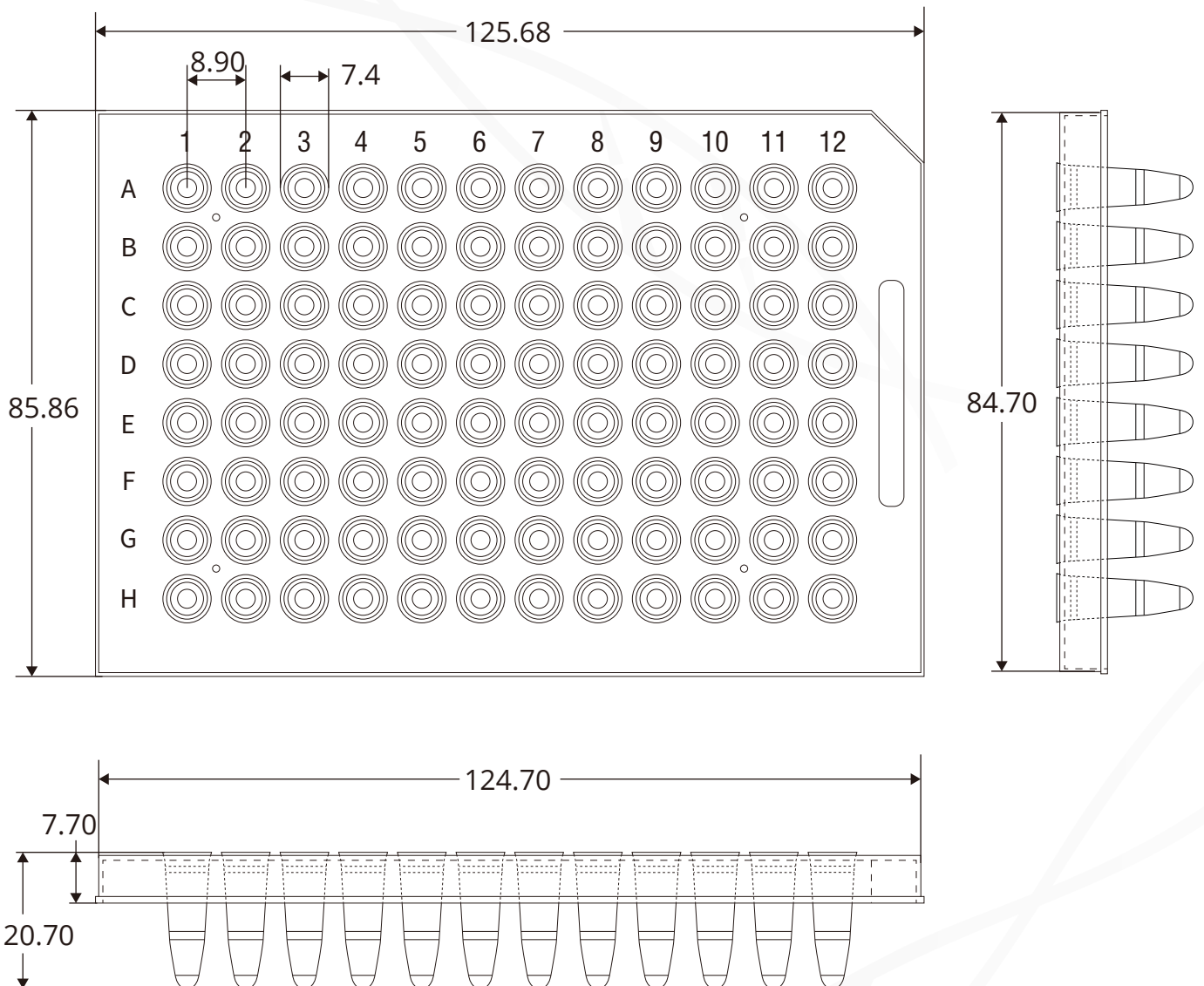

(Unit: mm)

SHAOXING GENFOLLOWER BIOTECH CO.,LTD.

Add: Eastern industrial park, Baiguan street, Shangyu district,
Shaoxing city, Zhejiang province, China
Email: GenFollower@Genfollower.com
Web: www.GenFollower.com
Fax: +86-575-82032762
Tel: +86-575-82936953

DATA SHEET

PCR Plates

ISO 9001

ISO 13485

Technical Drawing - T96HS-02N

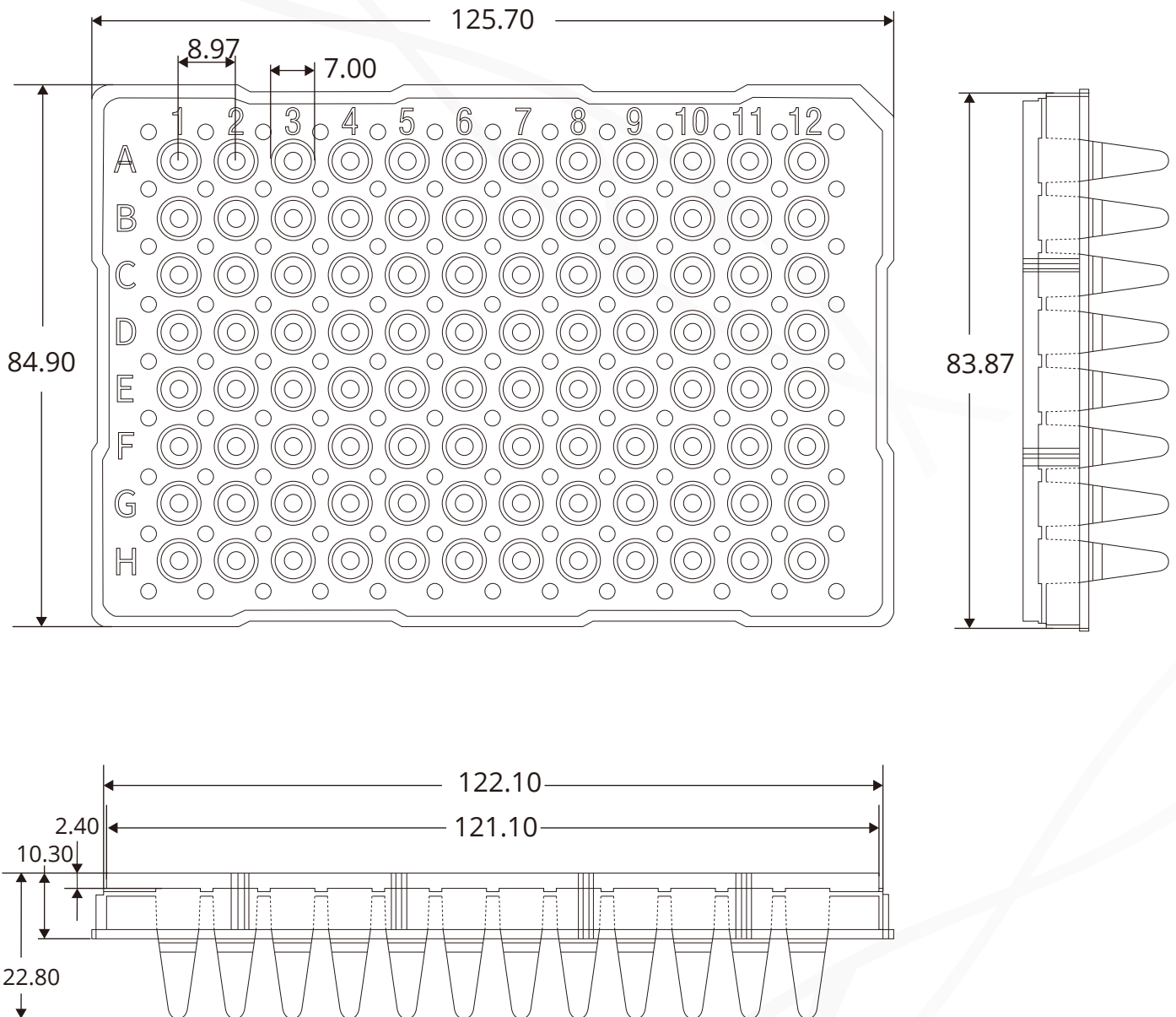

(Unit: mm)

SHAOXING GENFOLLOWER BIOTECH CO.,LTD.

Add: Eastern industrial park, Baiguan street, Shangyu district,
Shaoxing city, Zhejiang province, China
Email: GenFollower@Genfollower.com
Web: www.GenFollower.com
Fax: +86-575-82032762
Tel: +86-575-82936953

 GenFollower®

DATA SHEET

Sealing films for plates

ISO ISO9001

ISO ISO13485

Features



Ensures contamination prevention between wells and provides a reliable seal.



Leaves no sticky residue on the plate after peeling off.

Offers a variety of sealing film options to choose from.

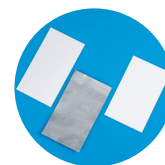

Sterilized, free from DNase, RNase, DNA, heavy metals, and pyrogens.



Raw Material

These products are manufactured using polyester resin or composite aluminum foil.

We Open To New Ideas!

Application

These sealing films are designed to fit various PCR plates, ensuring optimal protection during the PCR cycle and sample storage. It provides a secure seal that prevents differential evaporation, safeguarding your experiments throughout the process.



SHAOXING GENFOLLOWER BIOTECH CO.,LTD.

Add: Eastern industrial park, Baiguan street, Shangyu district,

Shaoxing city, Zhejiang province, China

Email: GenFollower@Genfollower.com

Web: www.GenFollower.com

Fax: +86-575-82032762

Tel: +86-575-82936953

**GenFollower**[®]

DATA SHEET

Sealing films for plates

ISO 9001

ISO 13485

Product Range

Cat.#	Description	Packaging
PCR96F	Common sealing film for PCR plates, Transparent, sterile, RNase and DNase free	100 PCS/BOX
QPCR96F-1	High transparent sealing film for PCR plates, Transparent, sterile, RNase and DNase free	100 PCS/BOX
AF00001	Aluminum sealing film for PCR plates, Non-permeable, Medical-grade Acrylic Adhesive, sterile, RNase and DNase free	100 PCS/BOX

Technical Drawing - PCR96F

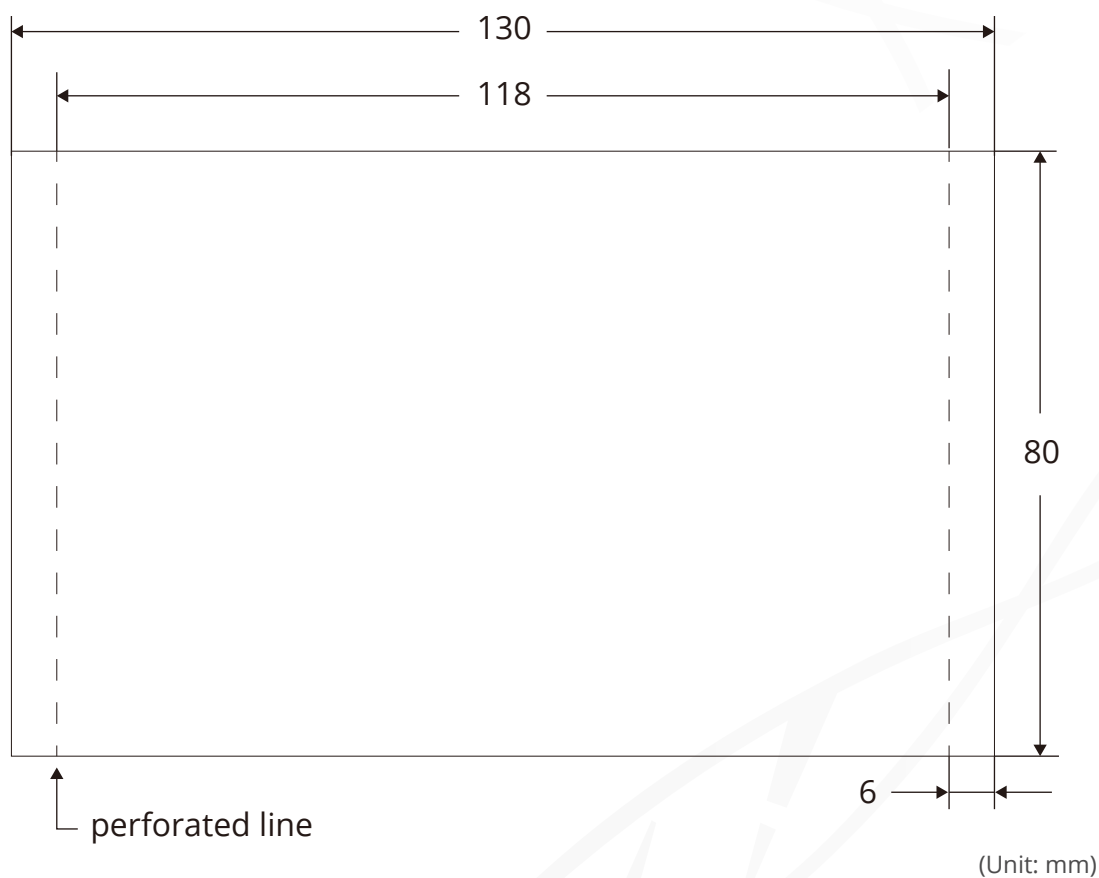

SHAOXING GENFOLLOWER BIOTECH CO.,LTD.

Add: Eastern industrial park, Baiguan street, Shangyu district,
Shaoxing city, Zhejiang province, China
Email: GenFollower@Genfollower.com
Web: www.GenFollower.com
Fax: +86-575-82032762
Tel: +86-575-82936953



DATA SHEET

Sealing films for plates

ISO 9001

ISO 13485

Technical Drawing - QPCR96F-1

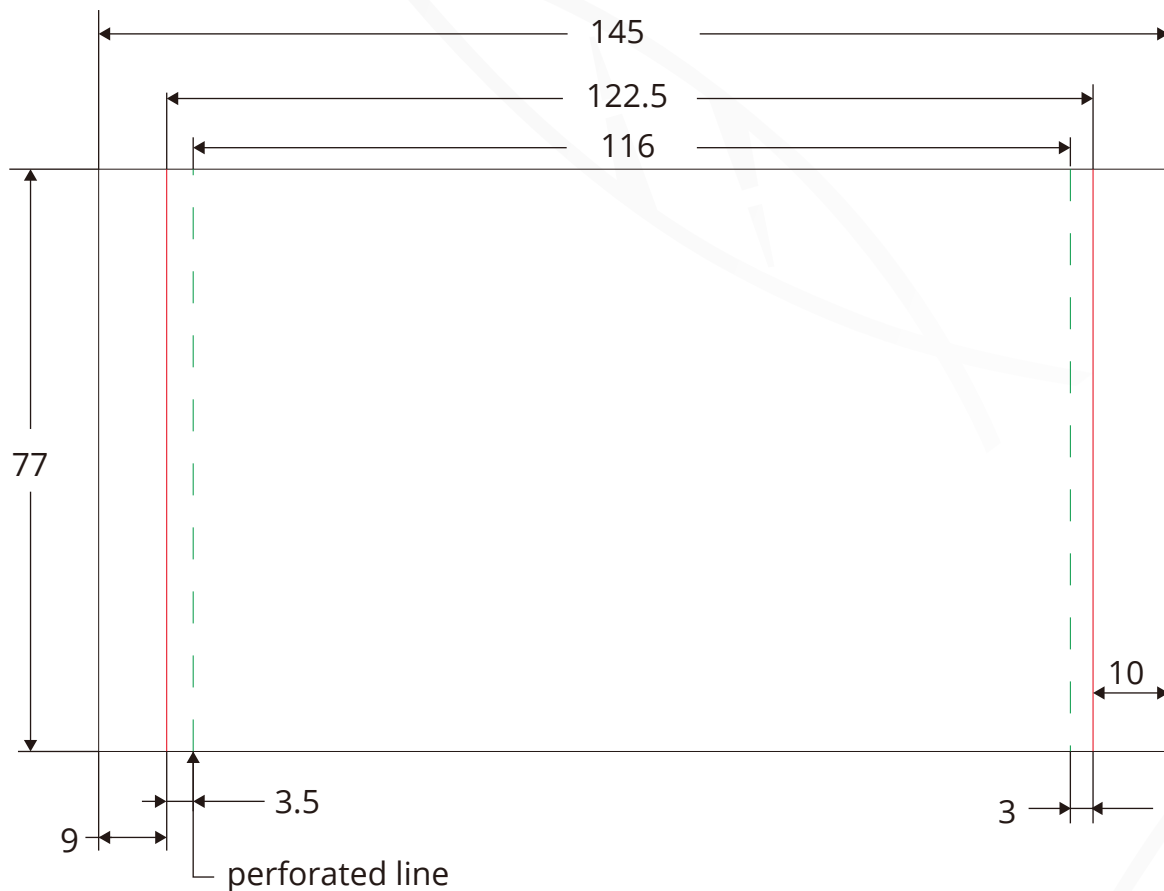

(Unit: mm)

SHAOXING GENFOLLOWER BIOTECH CO.,LTD.

Add: Eastern industrial park, Baiguan street, Shangyu district,

Shaoxing city, Zhejiang province, China

Email: GenFollower@Genfollower.com

Web: www.GenFollower.com

Fax: +86-575-82032762

Tel: +86-575-82936953



DATA SHEET

Sealing films for plates

ISO 9001

ISO 13485

Technical Drawing - AF00001

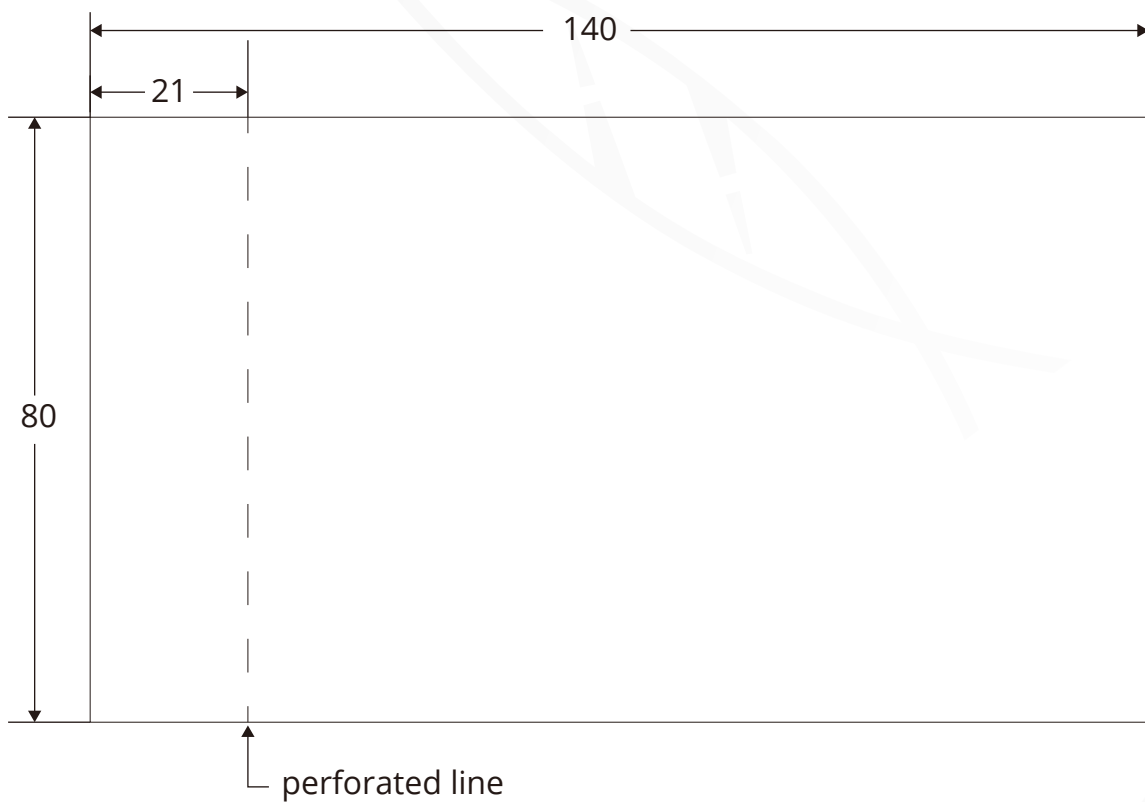

(Unit: mm)

SHAOXING GENFOLLOWER BIOTECH CO.,LTD.

Add: Eastern industrial park, Baiguan street, Shangyu district,

Shaoxing city, Zhejiang province, China

Email: GenFollower@Genfollower.com

Web: www.GenFollower.com

Fax: +86-575-82032762

Tel: +86-575-82936953

GenFollower[®]