

DATA SHEET

Deep Well Plates

ISO 9001

Features



Crafted from polypropylene, it boasts excellent chemical resistance.



Following the ANSI-SLAS standard footprint, it's well-suited for use at pipetting stations.

Offered in configurations of 48, 96, and 384-well plates.

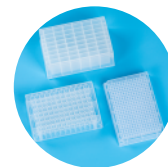

Meets a range of experimental needs through its variety of bottom and well shapes.

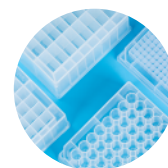

Provided in a sterile state and guaranteed to be DNase and RNase-free.



Raw Material

These plates are manufactured using pure polypropylene material.

Application

Deep well plates are a fundamental laboratory tool, featuring grid-patterned wells of larger dimensions compared to standard microplates. They find widespread use across diverse sectors, including research, biotechnology, and the pharmaceutical industry. Applications encompass sample storage, DNA and RNA extraction, liquid handling, automation, and more.

We Open To New Ideas!



SHAOXING GENFOLLOWER BIOTECH CO.,LTD.

Add: Eastern industrial park, Baiguan street, Shangyu district, Shaoxing city, Zhejiang province, China

Email: GenFollower@Genfollower.com

Web: www.GenFollower.com

Fax: +86-575-82032762

Tel: +86-575-82936953

**GenFollower**[®]

DATA SHEET

Deep Well Plates

ISO 9001

Product Range

CAT	Description	Packaging
DW00005	120uL * 384 deep well plates, square well, V bottom, ANSI-SLAS standard, sterile, RNase and DNase free	10 PCS/Bag, 10 Bags/Case
DW00006	1.2mL * 96 deep well plates, square well, V bottom, ANSI-SLAS standard, sterile, RNase and DNase free	10 PCS/Bag, 10 Bags/Case
DW00013	1.2mL * 96 deep well plates, square well, U bottom, ANSI-SLAS standard, sterile, RNase and DNase free	5 PCS/Bag, 10 Bags/Case
DW00014	1.2mL * 96 deep well plates, round well, U bottom, ANSI-SLAS standard, sterile, RNase and DNase free	10 PCS/Bag, 10 Bags/Case
DW00010	2.0mL * 96 deep well plates, round well, U bottom, ANSI-SLAS standard, sterile, RNase and DNase free	5 PCS/Bag, 10 Bags/Case
DW00008	2.2mL * 96 deep well plates, square well, Conical bottom, ANSI-SLAS standard, sterile, RNase and DNase free	5 PCS/Bag, 10 Bags/Case
DW00009	2.2mL * 96 deep well plates, square well, V bottom, ANSI-SLAS standard, sterile, RNase and DNase free	5 PCS/Bag, 10 Bags/Case
DW00011	2.2mL * 96 deep well plates, square well, U bottom, ANSI-SLAS standard, sterile, RNase and DNase free	5 PCS/Bag, 10 Bags/Case
DW00012	2.2mL * 96 deep well plates, square well, U bottom, ANSI-SLAS standard, sterile, RNase and DNase free	5 PCS/Bag, 10 Bags/Case
DW00007	5.0mL * 48 deep well plates, rectangle well, V bottom, ANSI-SLAS standard, sterile, RNase and DNase free	5 PCS/Bag, 10 Bags/Case

SHAOXING GENFOLLOWER BIOTECH CO.,LTD.

Add: Eastern industrial park, Baiguan street, Shangyu district, Shaoxing city, Zhejiang province, China

Email: GenFollower@Genfollower.com

Web: www.GenFollower.com

Fax: +86-575-82032762

Tel: +86-575-82936953

**GenFollower**[®]

 **Technical Drawing - DW00005**

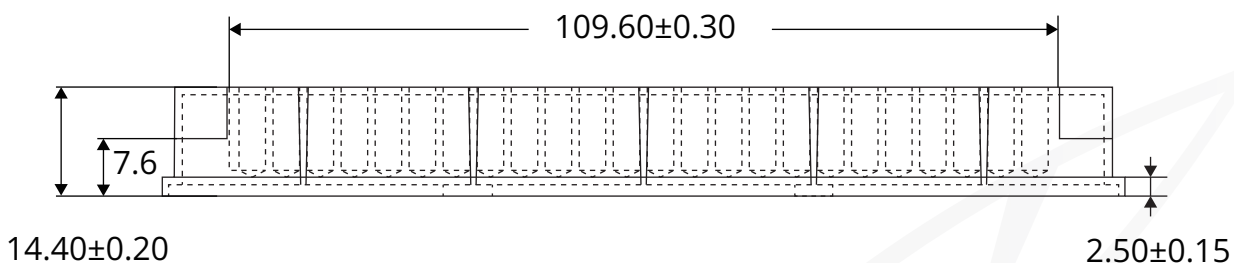
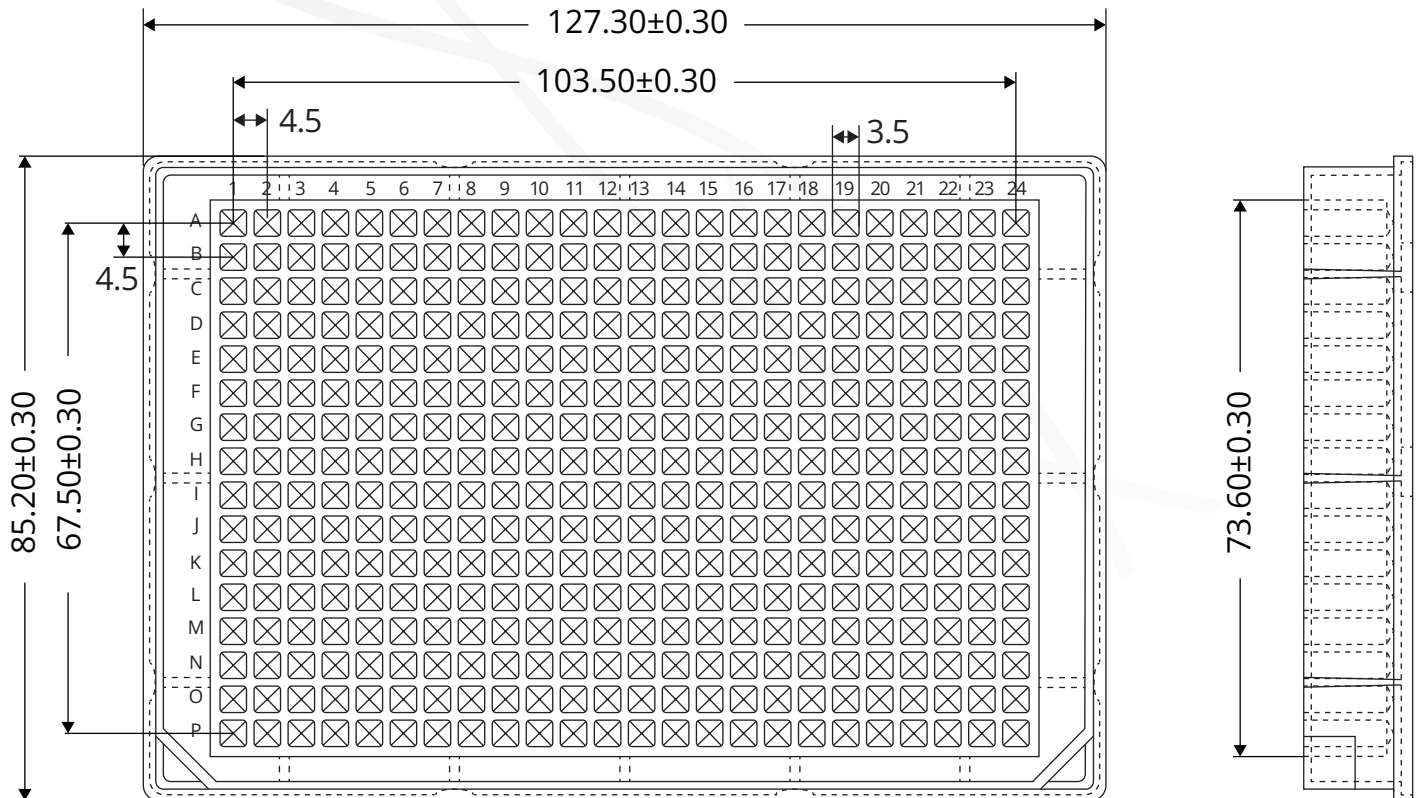

(Unit: mm)

SHAOXING GENFOLLOWER BIOTECH CO.,LTD.

Add: Eastern industrial park, Baiguan street, Shangyu district, Shaoxing city, Zhejiang province, China

Email: GenFollower@Genfollower.com

Web: www.GenFollower.com

Fax: +86-575-82032762

Tel: +86-575-82936953

DATA SHEET

Deep Well Plates

ISO 9001

Technical Drawing - DW00006

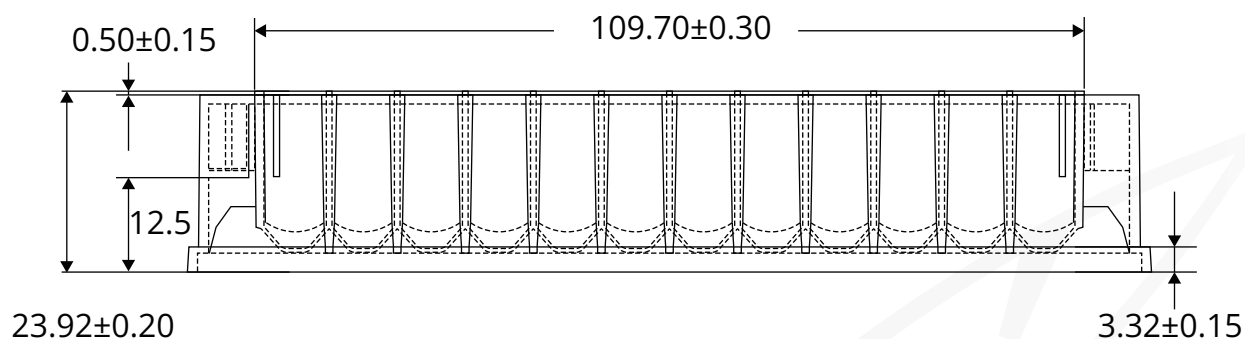
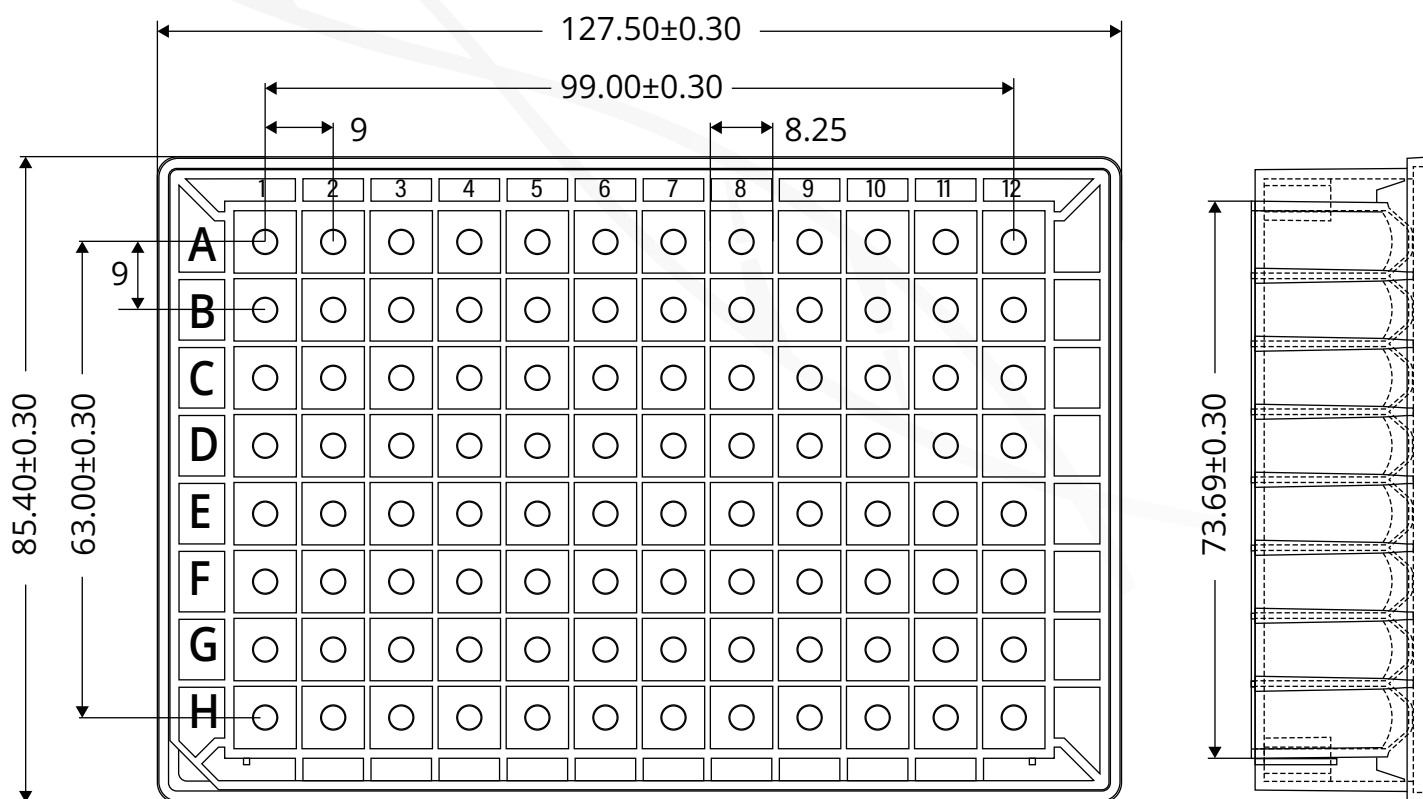

(Unit: mm)

SHAOXING GENFOLLOWER BIOTECH CO.,LTD.

Add: Eastern industrial park, Baiguan street, Shangyu district, Shaoxing city, Zhejiang province, China

Email: GenFollower@Genfollower.com

Web: www.GenFollower.com

Fax: +86-575-82032762

Tel: +86-575-82936953



Technical Drawing - DW00013

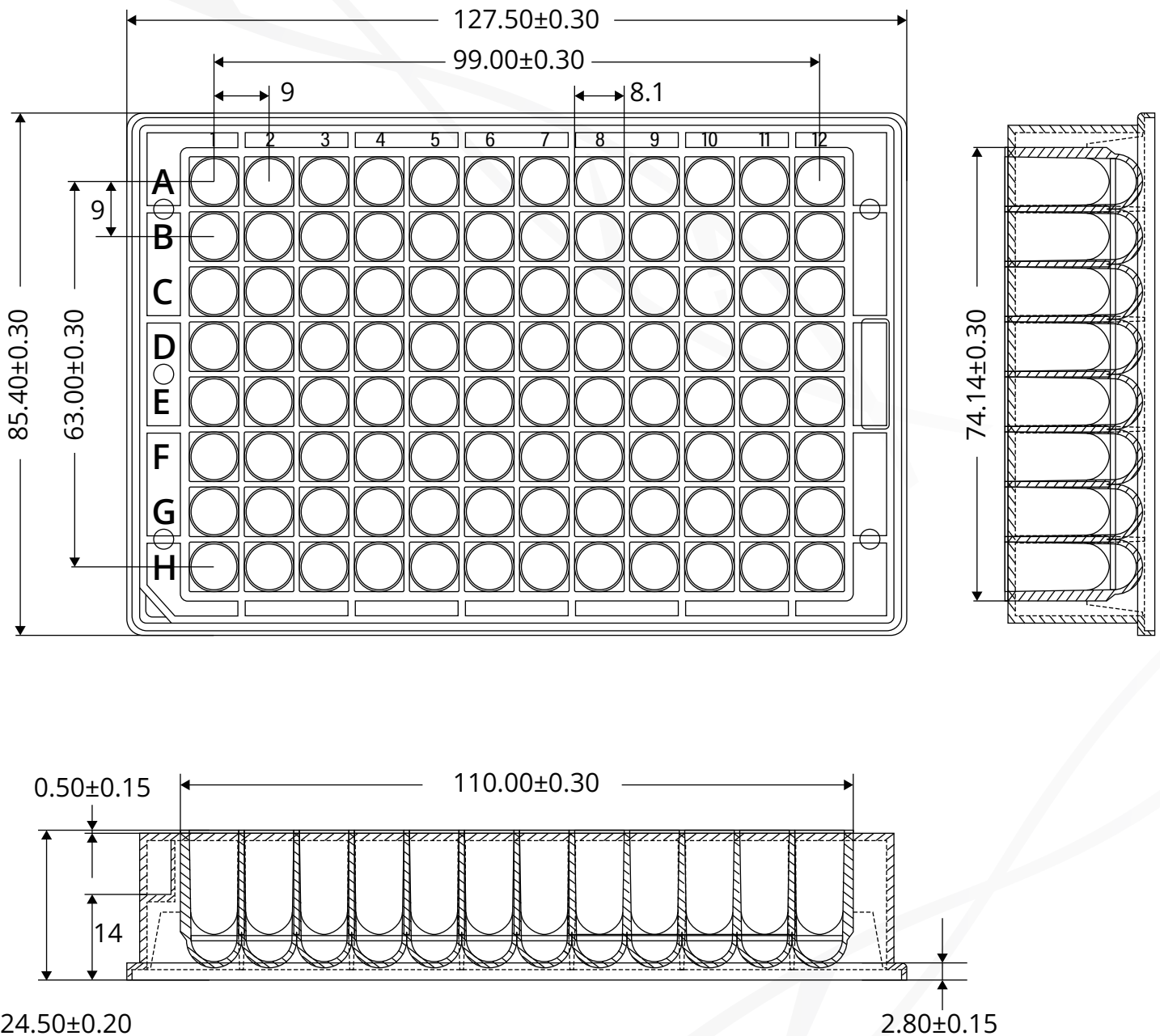

(Unit: mm)

SHAOXING GENFOLLOWER BIOTECH CO.,LTD.

Add: Eastern industrial park, Baiguan street, Shangyu district, Shaoxing city, Zhejiang province, China

Email: GenFollower@Genfollower.com

Web: www.GenFollower.com

Fax: +86-575-82032762

Tel: +86-575-82936953

DATA SHEET

Deep Well Plates

ISO 9001

Technical Drawing - DW00014

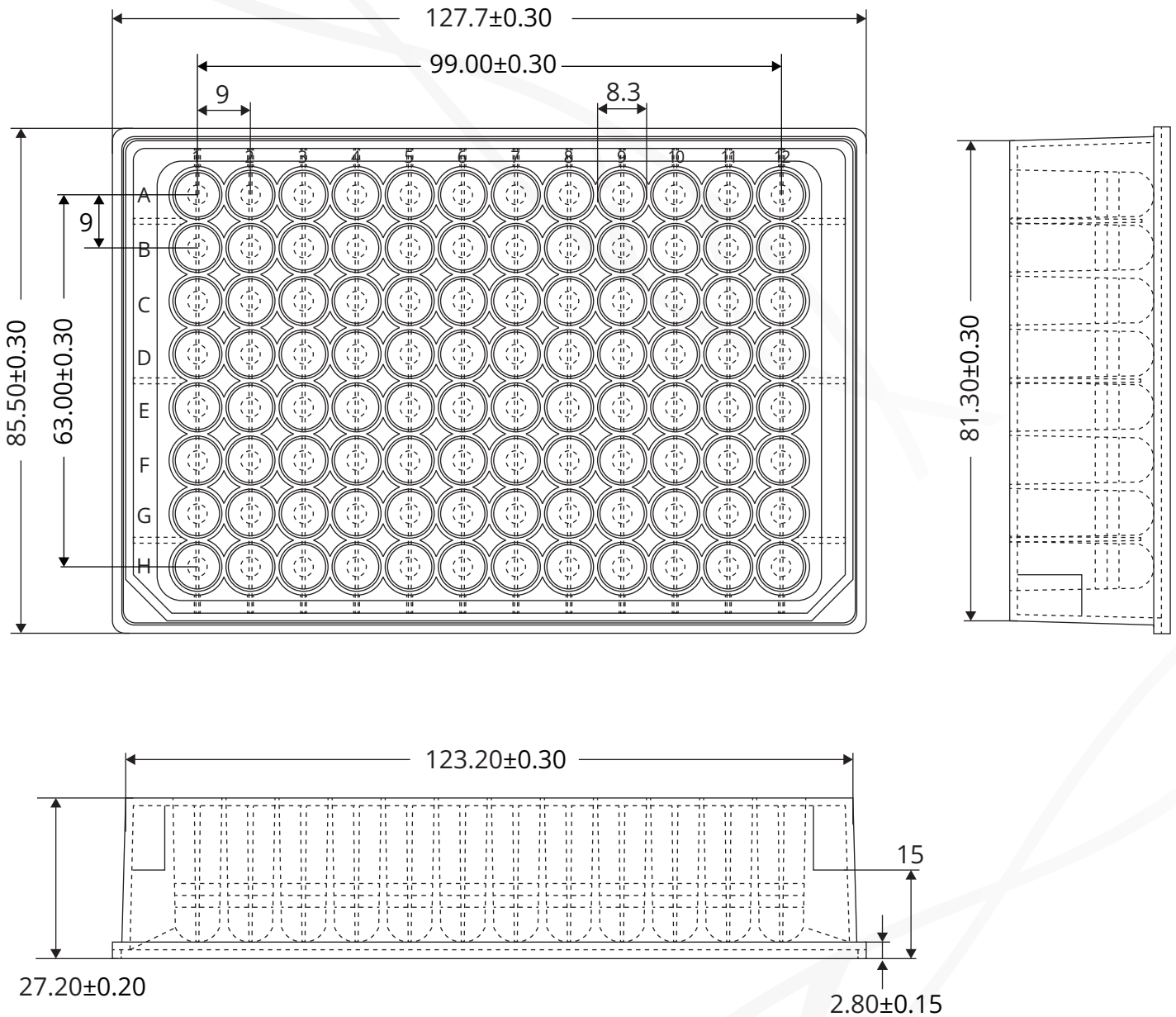

(Unit: mm)

SHAOXING GENFOLLOWER BIOTECH CO.,LTD.

Add: Eastern industrial park, Baiguan street, Shangyu district,
Shaoxing city, Zhejiang province, China

Email: GenFollower@Genfollower.com

Web: www.GenFollower.com

Fax: +86-575-82032762

Tel: +86-575-82936953

**GenFollower**[®]

DATA SHEET

Deep Well Plates

ISO 9001

Technical Drawing - DW00010

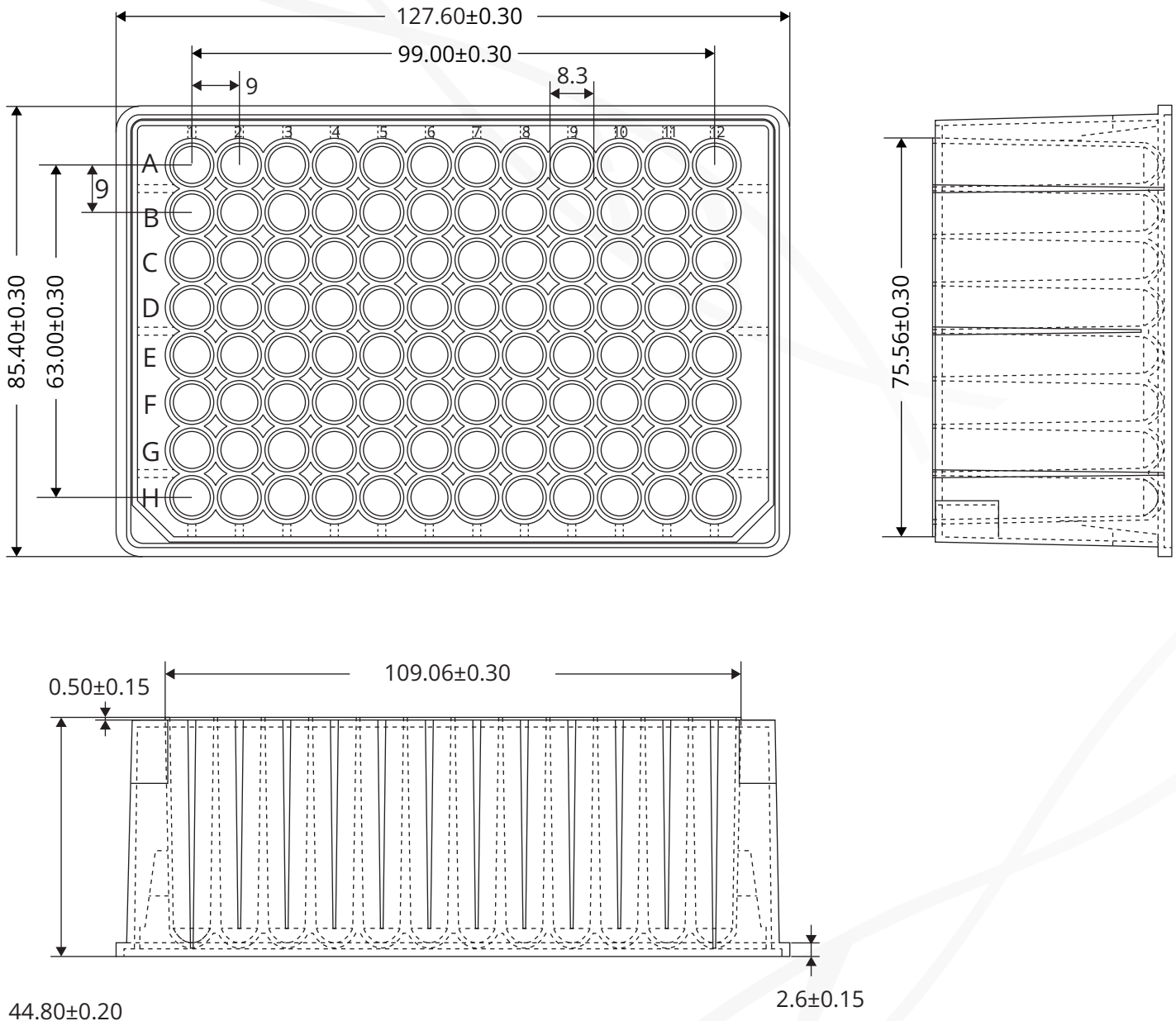

(Unit: mm)

SHAOXING GENFOLLOWER BIOTECH CO.,LTD.

Add: Eastern industrial park, Baiguan street, Shangyu district, Shaoxing city, Zhejiang province, China

Email: GenFollower@Genfollower.com

Web: www.GenFollower.com

Fax: +86-575-82032762

Tel: +86-575-82936953



DATA SHEET

Deep Well Plates

ISO 9001

Technical Drawing - DW00008

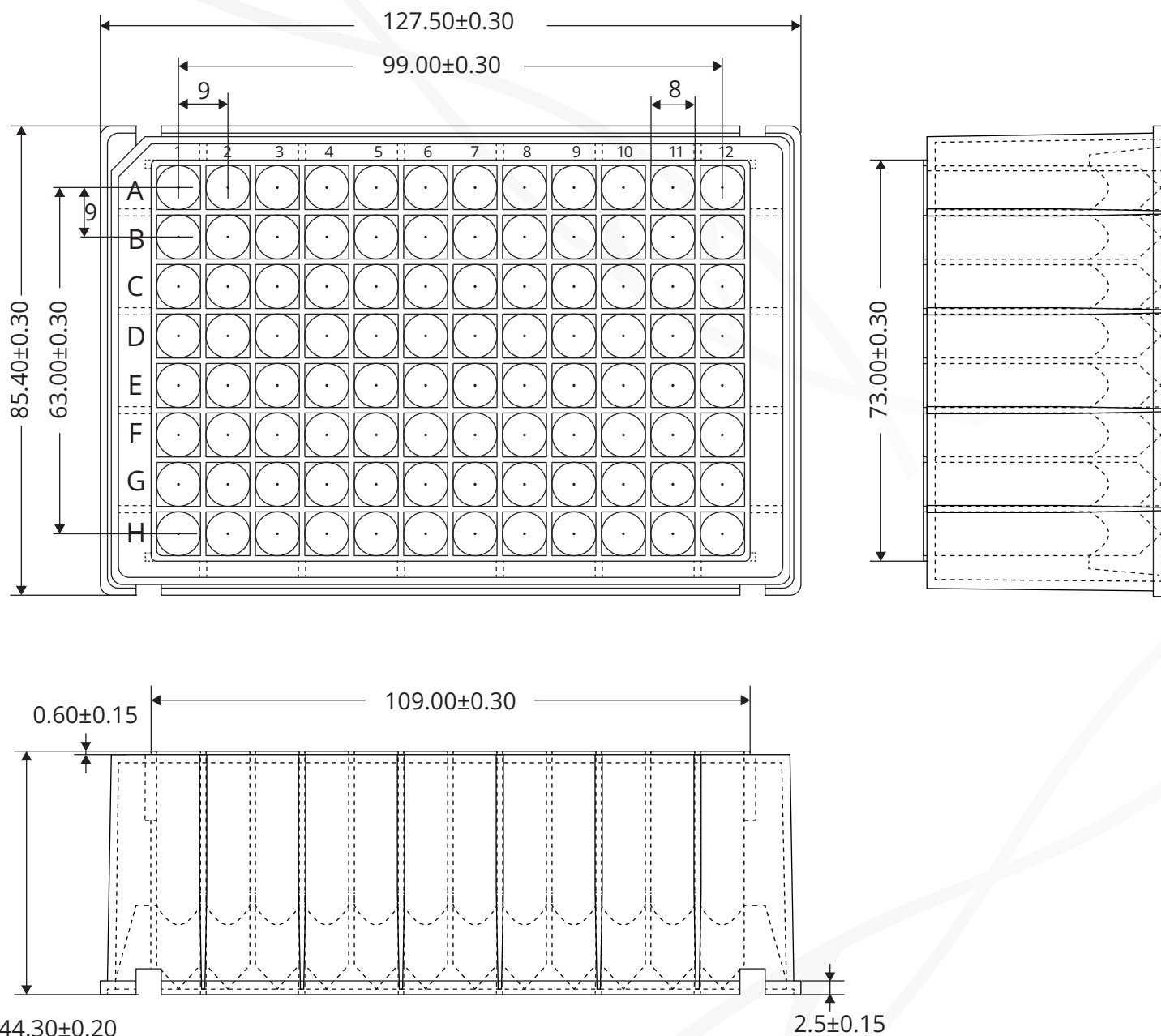

(Unit: mm)

SHAOXING GENFOLLOWER BIOTECH CO.,LTD.

Add: Eastern industrial park, Baiguan street, Shangyu district, Shaoxing city, Zhejiang province, China

Email: GenFollower@Genfollower.com

Web: www.GenFollower.com

Fax: +86-575-82032762

Tel: +86-575-82936953



 **Technical Drawing - DW00009**

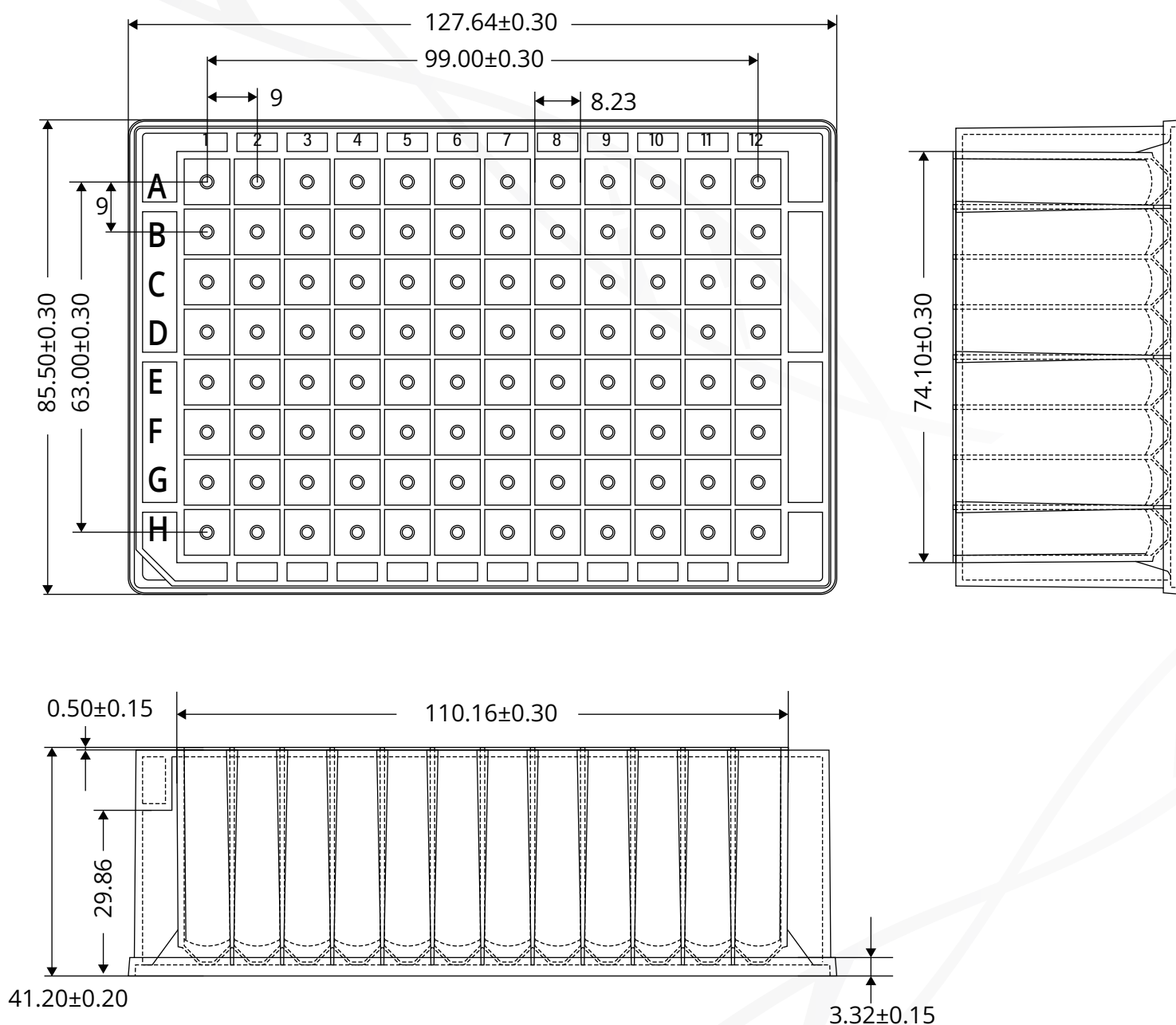

(Unit: mm)

SHAOXING GENFOLLOWER BIOTECH CO.,LTD.

Add: Eastern industrial park, Baiguan street, Shangyu district, Shaoxing city, Zhejiang province, China

Email: GenFollower@Genfollower.com

Web: www.GenFollower.com

Fax: +86-575-82032762

Tel: +86-575-82936953

DATA SHEET

Deep Well Plates

ISO 9001

Technical Drawing - DW00011

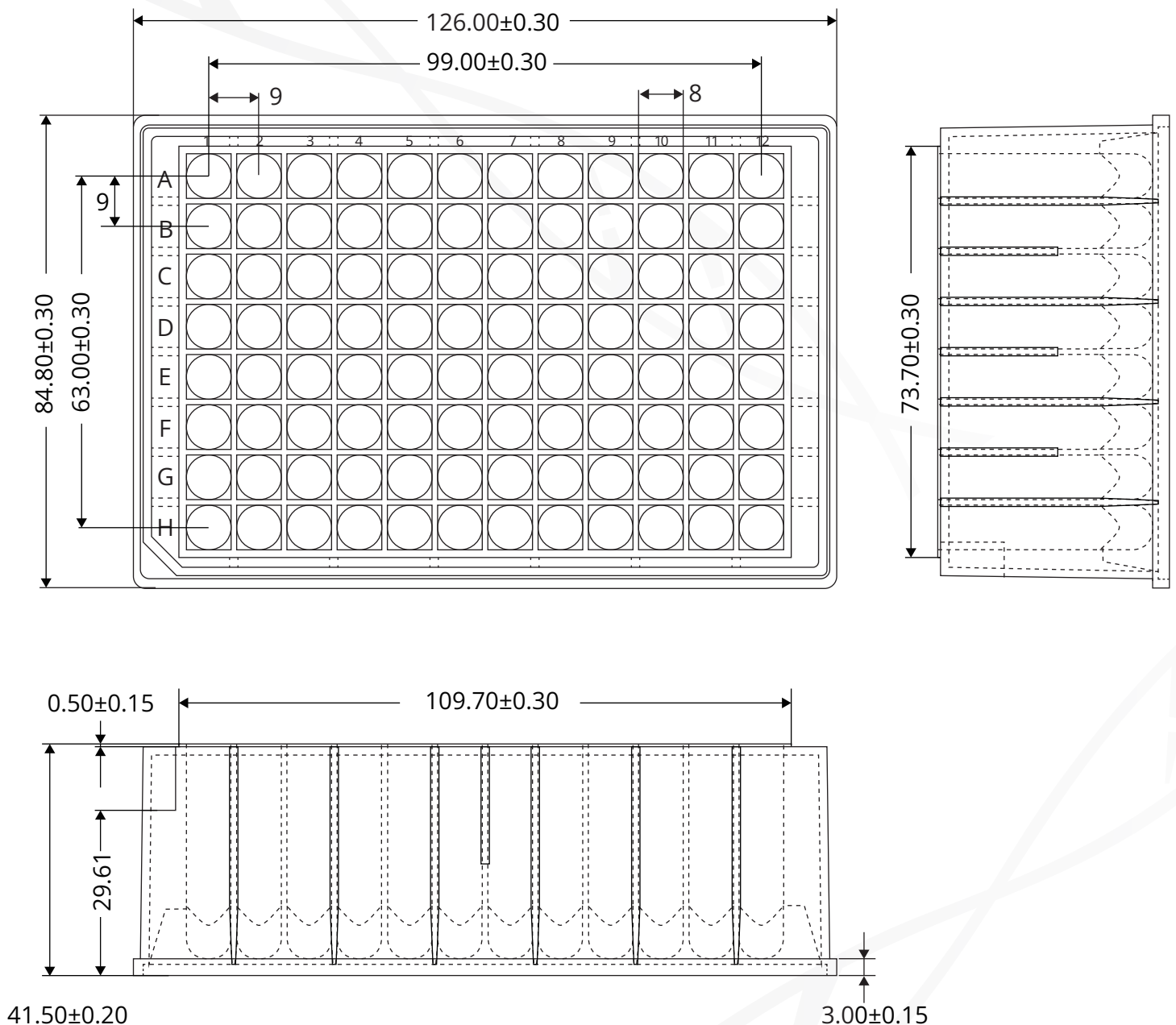

(Unit: mm)

SHAOXING GENFOLLOWER BIOTECH CO.,LTD.

Add: Eastern industrial park, Baiguan street, Shangyu district, Shaoxing city, Zhejiang province, China

Email: GenFollower@Genfollower.com

Web: www.GenFollower.com

Fax: +86-575-82032762

Tel: +86-575-82936953

 GenFollower®

Technical Drawing - DW00012

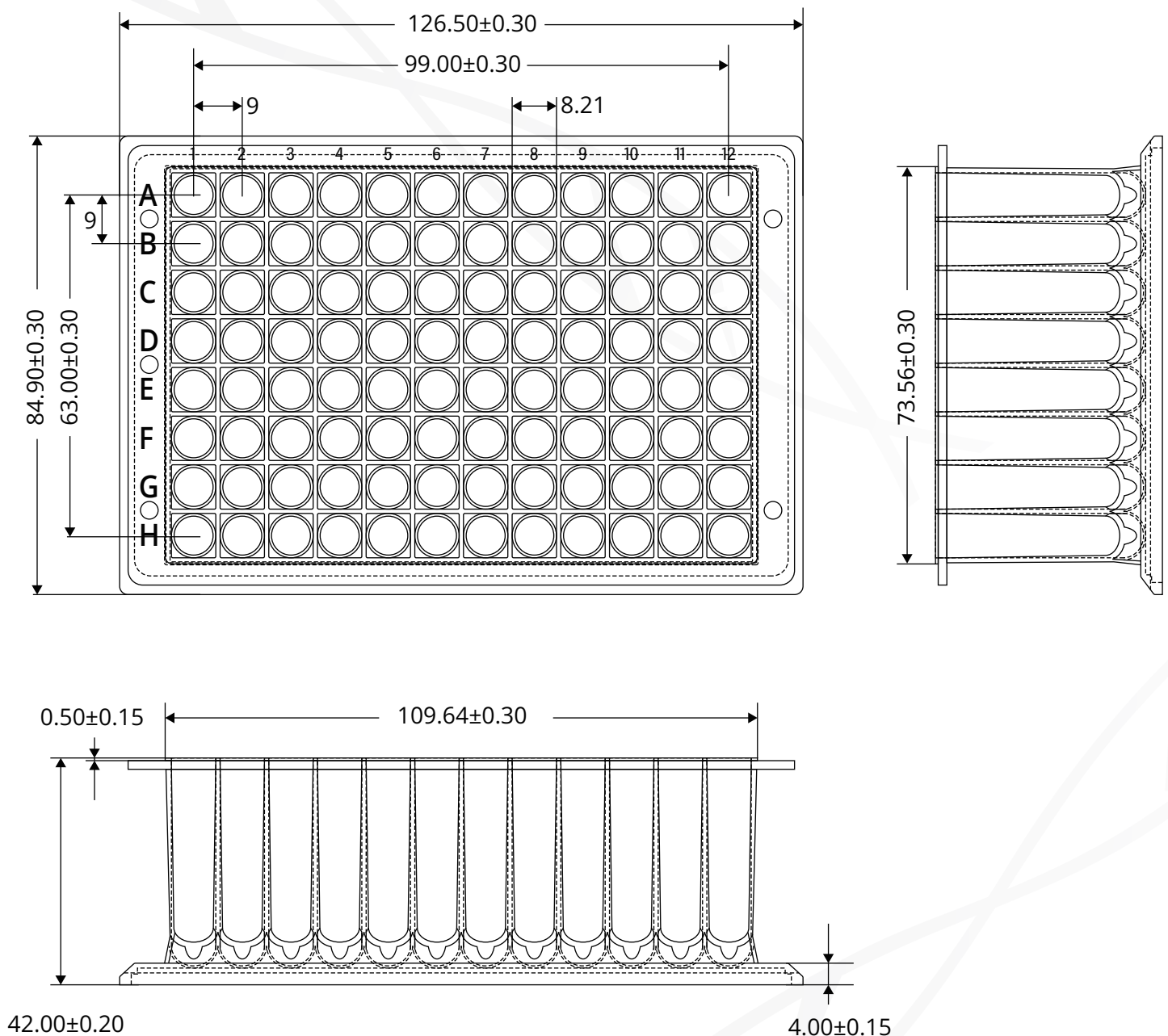

(Unit: mm)

SHAOXING GENFOLLOWER BIOTECH CO.,LTD.

Add: Eastern industrial park, Baiguan street, Shangyu district, Shaoxing city, Zhejiang province, China

Email: GenFollower@Genfollower.com

Web: www.GenFollower.com

Fax: +86-575-82032762

Tel: +86-575-82936953

DATA SHEET

Deep Well Plates

ISO 9001

Technical Drawing - DW00007

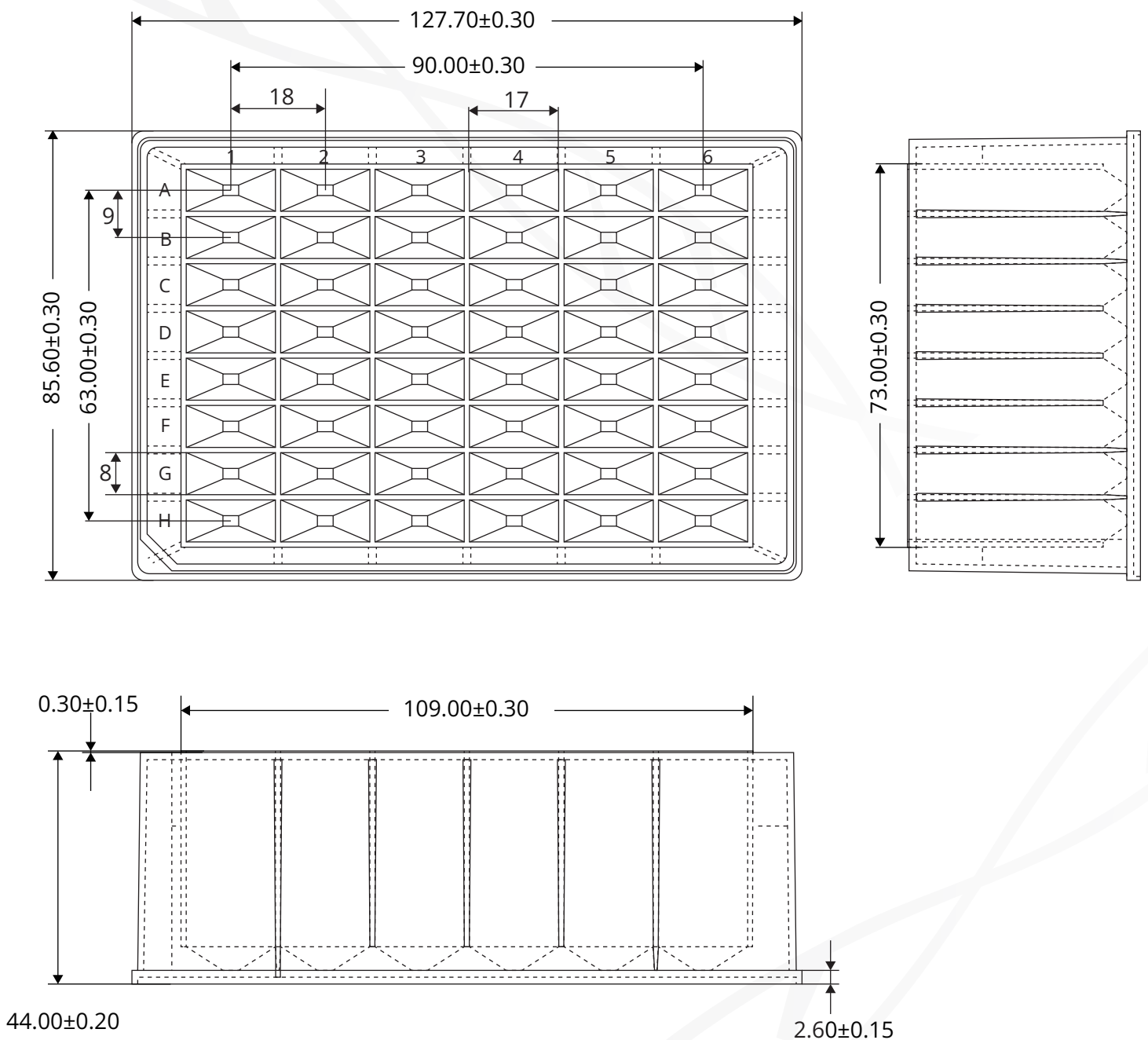

(Unit: mm)

SHAOXING GENFOLLOWER BIOTECH CO.,LTD.

Add: Eastern industrial park, Baiguan street, Shangyu district, Shaoxing city, Zhejiang province, China

Email: GenFollower@Genfollower.com

Web: www.GenFollower.com

Fax: +86-575-82032762

Tel: +86-575-82936953

 GenFollower®

DATA SHEET

Tip Combs for Deep Well Plates

ISO ISO9001

Features



Crafted from high-quality polypropylene, it boasts strong chemical resistance.



Free from Dnase, Rnase and human DNA.

Product Range

CAT	Description	Packaging
DKT0096	96 Tip Combs, sterile, DNase and RNase free	2 PCS/Bag, 5 Bags/Box, 10 Boxes/Case

Raw Material

These tip combs are produced using pure polypropylene material.

Application

These products securely position the magnetic rod, enhancing its ability to efficiently adsorb and separate within the sample solution. Polypropylene's inherent low binding affinity towards biomolecules makes it an optimal choice for handling magnetic particles, leading to exceptional recovery of magnetic beads. They are frequently employed alongside deep well plates for nucleic acid extraction experiments.

We Open To New Ideas!



SHAOXING GENFOLLOWER BIOTECH CO.,LTD.

Add: Eastern industrial park, Baiguan street, Shangyu district, Shaoxing city, Zhejiang province, China

Email: GenFollower@Genfollower.com

Web: www.GenFollower.com

Fax: +86-575-82032762

Tel: +86-575-82936953



GenFollower[®]

DATA SHEET

Tip Combs for Deep Well Plates

ISO 9001

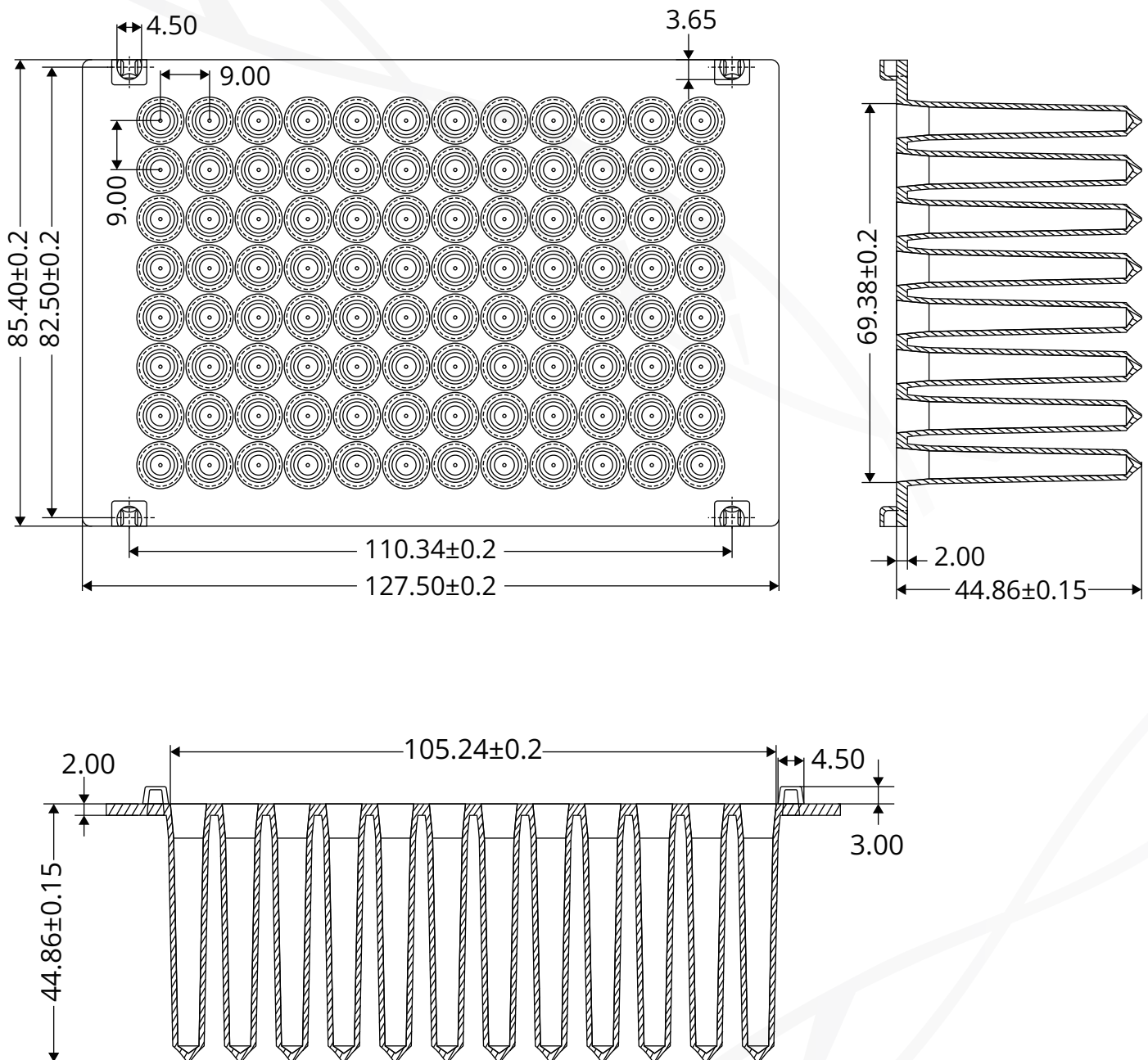
Technical Drawing - DKT0096



(Unit: mm)

SHAOXING GENFOLLOWER BIOTECH CO.,LTD.

Add: Eastern industrial park, Baiguan street, Shangyu district,
Shaoxing city, Zhejiang province, China

Email: GenFollower@Genfollower.com

Web: www.GenFollower.com

Fax: +86-575-82032762

Tel: +86-575-82936953

 GenFollower®